

TOYOTA

COROLLA S

2014 - 2016

LED DRL

Part Number: TCO-714S

**Kit Contents**

Item #	Quantity Reqd.	Description
1	2	DRL's bezels w/LED DRL
2	1	Driver Box
3	1	Harness bag
4	1	User's card
5	1	Switch
6	2	Drilling Jigs
7	2	Spacers

**Hardware Bag Contents**

Item #	Quantity Reqd.	Description
1	1	Hood Wire Harness
2	1	Cabin Wire Harness
3	25	8" Wire ties
4	2	Black T-Taps
5	1	14" wire tie
6	1	Relay
7	2	Phillip Head Screws
8	2	DRL Connectors

**General Applicability**

S models

**Conflicts**





-

**Recommended Tools**

<b>Safety Tools</b>	
Safety Glasses	
Protective tape	
Electrical Tape	
<b>Installation Tools</b>	
10mm Wrench	
Phillips Screw Driver	
Pliers	
Panel Tool Removal	
Side Cutters	
Torque Wrench	
<b>Special Chemicals</b>	
3M Silicon Sealant	

Mandatory

Legend

	<b>STOP:</b> Damage to the vehicle may occur. Do not proceed until process has been complied with.
	<b>OPERATOR SAFETY:</b> Use caution to avoid risk of injury
	<b>CRITICAL PROCESS:</b> Proceed with caution to ensure a quality installation. These points will be audited on a completed vehicle installation
	<b>TOOLS &amp; EQUIPMENT:</b> This calls out the specific tools and equipment required for this process
	<b>REVISION MARK:</b> This mark highlights a change in installation with respect to previous issue.

**SPECIAL NOTE:**

After **Auer Automotive Safety** mandated preparatory steps have been taken, the installation sequence is the suggested method for completing the accessory installation. In some instances the suggested sequence is written for one associate to install and in others the sequence is given as part of a team accessory installation. Unless otherwise stated in the document, the associates may perform the installation steps in any order to make the installation as efficient as possible while maintaining consistent quality. Also some items listed to be removed may not need to be removed if caution is taken to not damage vehicle.

Care must be taken when installing this accessory to ensure damage does not occur to the vehicle. The installation of this accessory should follow approved guidelines to ensure quality installation.

## Preparation



Remove negative battery cable

## Installation

1. Route the DRL wire harness along the driver side from the battery towards the bulkhead of the vehicle. Secure the wire harness with wire ties as needed (picture 1)



Picture 1

2. Locate the large vehicle harness grommet on the driver side. If accessible, cut the auxiliary wiring access nipple off the grommet or cut ¼" slit in grommet. Using fish tool Push the DRL wire harness through grommet. Note: Extra caution should be taken not to damage the pin connectors. Seal with 3M Silicone sealant (picture 2).



Picture 2

## Vehicle Disassembly

3. Remove the driver's scuff plate, by disengaging the claws (picture 3)

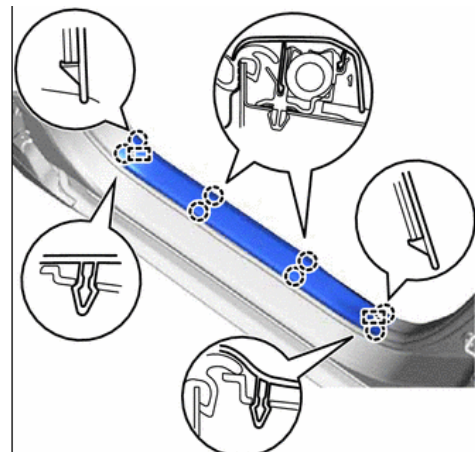

Picture 3

4. Remove the side kick panel by removing the clip (picture 4)

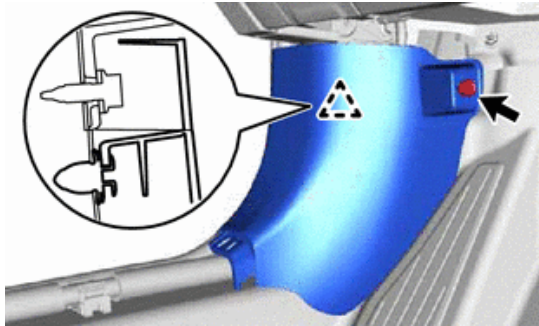

Picture 4

5. Remove side instrument panel. Using a pry tool, disengage the clips (picture 5)

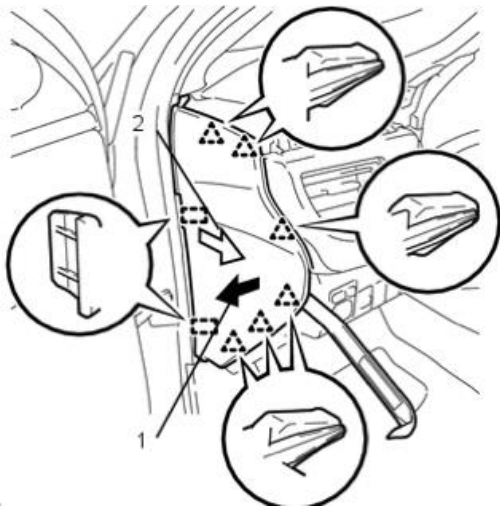

Picture 5

6. Remove left side switch panel: Remove switch knockout, then remove screw and claws securing panel (pictures 6 and 6A)

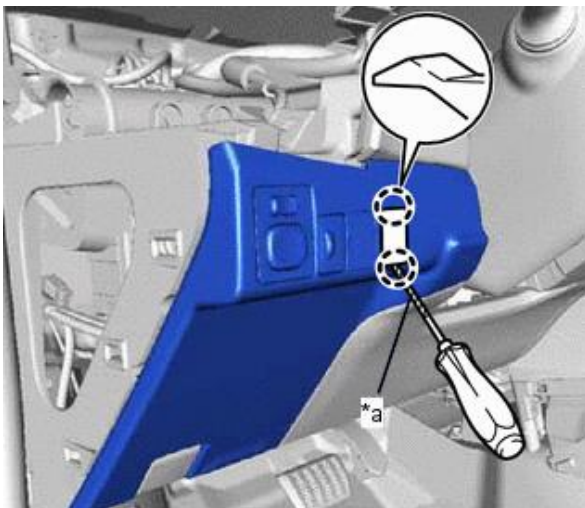

Picture 6

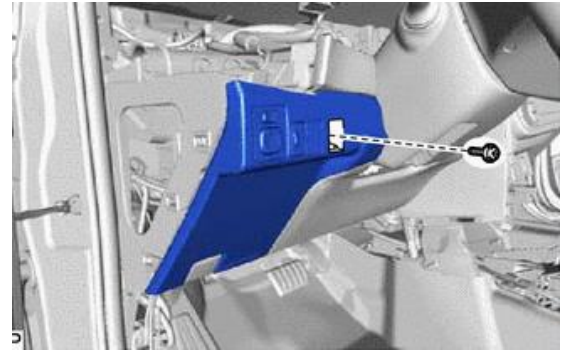

Picture 6A

7. Use an empty switch knock out on left panel, then mount switch into switch knock out (picture 7)



Picture 7

8. Locate the wires that were pushed through the grommet in step 5. It will be the grommet above the gas pedal. Route the wire harness to reach the area on left of the steering wheel and tie wrap to factory harness (picture 8)



Picture 8

9. Using the driver box as a guide, push the pins of the DRL wire harness into the connector supplied in kit. Make sure that the wire colors of the connectors are aligned with the wire colors of the driver box: black with black and red with red, etc (picture 9)

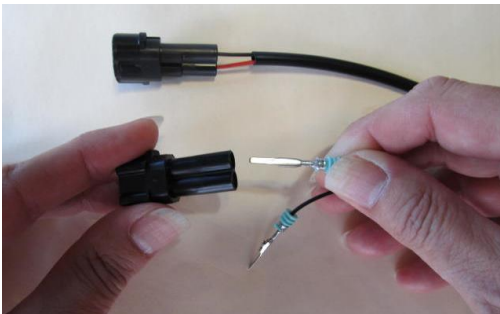

Picture 9

10. Connect the driver box to the wire harness (make sure wire colors are aligned).
11. Using a 14" wire tie, secure the driver box next to the main junction block (pic. 10).



Picture 10

12. Secure black ground wire to ground point behind kick panel (picture 11).

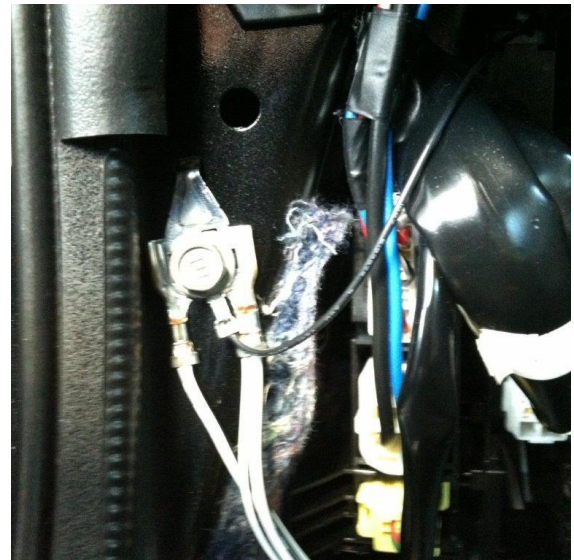

Picture 11

13. At connector E22 install a black T-Tap to pin 19, gray wire. This is part of the power mirror switch circuit. Then connect the red wire from DRL harness to T-tap. Connector E22 is located behind the door mirror control switch (pictures 12, 13 and 14)

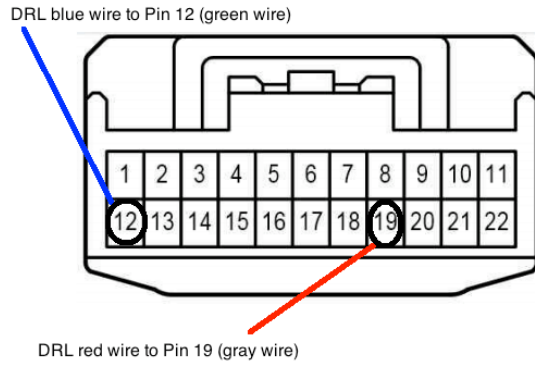

Picture 12

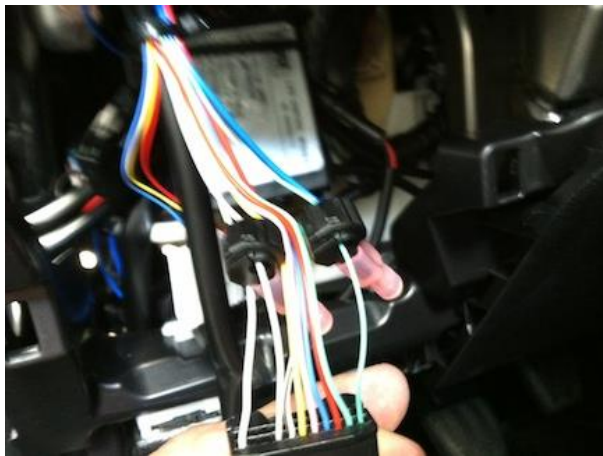

Picture 13

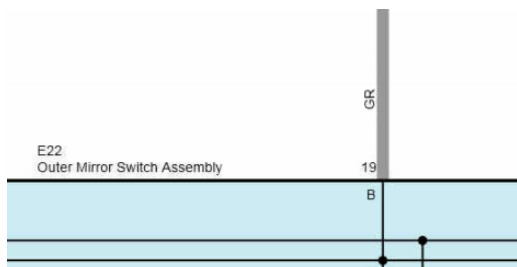

Picture 14: Door mirror control switch

- At connector E22 (power mirror control switch), pin 12, install a black T-Tap to the light green wire. Then connect the blue wire from DRL harness to t-tap. (pictures 12, 13 & 15).

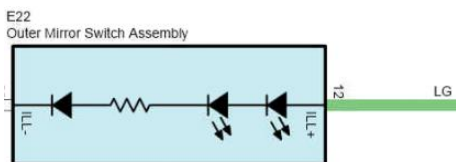

Picture 15

- Secure relay in vertically, in a 12:00 position, so moisture does not condensate inside. Then secure excess wire from t-taps and fuse to main wire harness (picture 16).



Picture 16

- Reinstall all panels and connectors inside car.

**Engine Compartment**

- On the driver side, route the DRL wire harness to reach the driver side fog light area.
- Remove lower splash shield. There are 6 screws and 2 push-pins on the bottom of bumper (picture 17). Then remove hard plastic shield above lower splash shield.

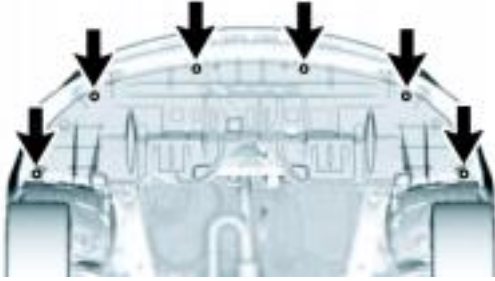

Picture 17

19. On the front of the grill, place the LH drilling jig (supplied in kit) on top slat of grill. Refer to picture for location of holes, then drill a 13mm hole and a 10 mm marked locations. Repeat step for RH side (picture 18).



Picture 18

20. At the driver side, push the outer side of DRL on grill and make sure the push pin snaps into place. Use the supplied mounting brackets and screws, and secure the inner side of the DRL to the grill (pictures 19 and 19A)



Picture19



Picture 19A

21. Repeat step 20 for other side of vehicle.  
 22. Run the DRL wire harness from the driver side towards the passenger side.  
 23. Wire tie DRL harness as needed. Leave enough lead to plug into DRL's (picture 21)

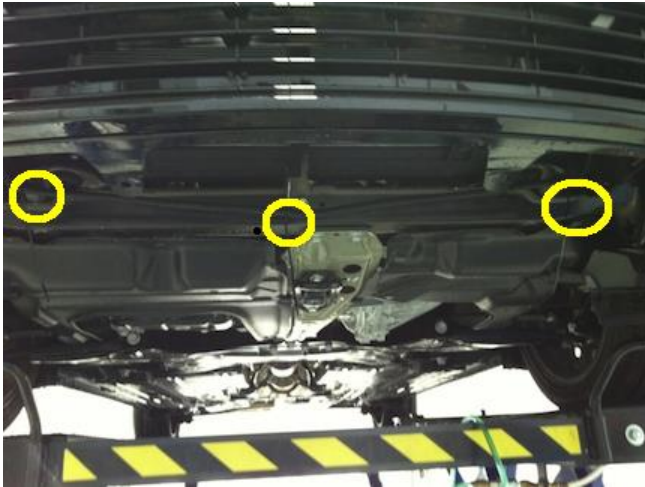

Picture 21

24. Connect DRL's to wire harness. Secure excess wires with wire ties (picture 22)



Picture 22

25. Reinstall lower splash shields
26. Reconnect negative battery terminal.  
Torque to 48 in/lbs

### Check System for Operation

1. DRL will work at full power when ignition switch is ON. DRL will dim out to DOT specifications when lights are ON.
2. If DRL switch position is off, DRL will not work at any time.

**Check**

Accessory Functions Checks

---

- DRL function.....
- All Panels snapped into place.....
- Battery Terminal.....
- Operation Guide.....

Vehicle Function checks

---

- Check functions all switch functions

**Look For:**

---

- ....
- Loose panels and switches
  - Re-torque battery terminals to 48 in-lb,
  - Place DRL operation guide inside glove box.

**VEHICLE FUNCTION CHECK**

AFTER ALL PANELS, COVERS AND COMPONENTS THAT WERE REMOVED HAVE BEEN REINSTALLED, TEST THOROUGHLY ALL MECHANICAL AND ELECTRICAL COMPONENTS DISCONNECTED AND/OR REMOVED FROM THE VEHICLE DURING THE INSTALLATION OF THIS ACCESSORY