

Part Number: TCA-912LE



Kit Contents

Item #	Quantity Req'd.	Description
1	2	DRL's bezels w/LED DRL
2	1	Driver Box
3	1	Harness bag
4	1	User's card
5	1	Switch

Hardware Bag Contents

Item #	Quantity Req'd.	Description
1	1	Hood Wire Harness
2	1	Cabin Wire Harness
3	21	Wire ties
4	2	T-Taps
5	1	15" wire tie
6	1	Relay

Service Parts

Item	Part number
DRL Housing LH	TCA-912LE-LL
DRL Housing RH	TCA-912LE-RL
Switch	TCA-712SE-SW
Wire Harness	TTA-712-WH
Driver Box	TCA-DRL-DB

General Applicability

L, LE models

Conflicts

- SE models

Recommended Tools

Safety Tools	
Safety Glasses	
Protective tape	
Electrical Tape	
Installation Tools	
10mm Wrench	
Phillips Screw Driver	
Pliers	
Panel Tool Removal	
Side Cutters	
Torque Wrench	
Special Chemicals	
3M Silicon Sealant	

Mandatory

Legend

	STOP: Damage to the vehicle may occur. Do not proceed until process has been complied with.
	OPERATOR SAFETY: Use caution to avoid risk of injury
	CRITICAL PROCESS: Proceed with caution to ensure a quality installation. These points will be audited on a completed vehicle installation
	TOOLS & EQUIPMENT: This calls out the specific tools and equipment required for this process
	REVISION MARK: This mark highlights a change in installation with respect to previous issue.

SPECIAL NOTE:

After **Auer Automotive Safety** mandated preparatory steps have been taken, the installation sequence is the suggested method for completing the accessory installation. In some instances the suggested sequence is written for one associate to install and in others the sequence is given as part of a team accessory installation. Unless otherwise stated in the document, the associates may perform the installation steps in any order to make the installation as efficient as possible while maintaining consistent quality. Also some items listed to be removed may not need to be removed if caution is taken to not damage vehicle.

Care must be taken when installing this accessory to ensure damage does not occur to the vehicle. The installation of this accessory should follow approved guidelines to ensure quality installation.

Preparation



- a. Place the vehicle in Park with the parking brake set.

Hybrid vehicles, the battery is in the trunk

- b. Remove the Battery Cover (for hybrid vehicles only)

Gas vehicles, the battery is in the Engine compartment

- c. If **Hybrid model**, **disconnect** the negative Battery terminal
- d. If **Gas engine model**, **remove** battery from vehicle.

- Note the Battery Cable Position as it will be re-installed in the same position

CAUTION: do not touch the positive battery terminal



Installation

1. From front of vehicle, run the DRL's wire harness on the driver side from the battery (Hybrid: from left front) towards the firewall of the car. Use wire ties as needed (pictures 1A ~1B)



Picture 1A: Remove screw of the base of filter box. Gently, lift the base and slide in the wire harness. Secure the screw



Picture 1B: wire tie to the harness just below the driver's side headlight



Picture 1C: wire tie to the ECU harness



Picture 1D: run wire behind air filter box



Picture 1E: wire tie left of brake reservoir

2. Locate the large vehicle harness grommet on the left side. If accessible, cut the auxiliary wiring access nipple off the grommet or cut 1/4" slit in grommet and push the red, black, black-white and red-white wires through firewall. Note: Extra caution should be taken not to damage the pin connectors. Seal with 3M Silicone sealant (picture 2)



Picture 2

Vehicle Disassembly

3. Remove driver side door scuff plate
 - a. Disengage with panel tool and remove (picture 3)

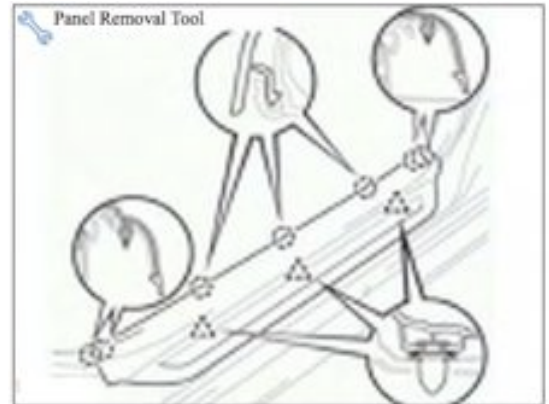

Picture 3

4. Remove the driver side cowl side trim
 - a. Unscrew the cowl side trim clip
 - b. Disengage two (2) clips and remove the cowl side trim (picture 4)

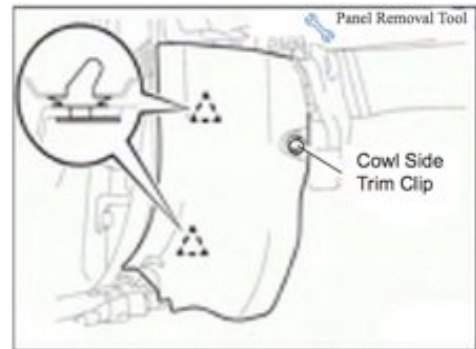

Picture 4

5. Remove the finish panel covering the knee airbag, lower airbag and move aside to access behind dashboard.
6. Remove side panel from dash, pry outward at front edge then pull straight back (pic. 5)



Picture 5

7. Remove dash plug then mount switch into switch knockout on left side of dash (pic. 6)



Picture 6

8. From inside the cabin, locate the wires that were pushed through in step 2. It will be the grommet above the gas pedal.
9. Route the wire harness to reach the area left of the steering wheel
10. Push the pins into the connector supplied in kit. Make sure that the wire colors of the connectors are aligned with the wire colors of the driver box: black with black and red with red, etc (picture 7)

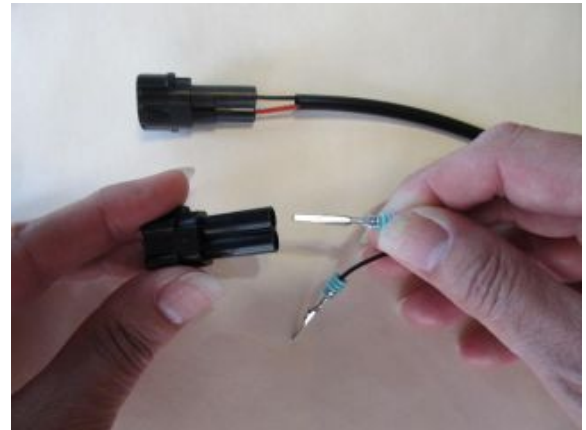

Picture 7

11. Connect the driver box to the wires pushed into the connectors on step 10 (make sure wire colors are aligned).
12. Using a 14" wire tie, secure the driver box next to the steering wheel column (picture 8)

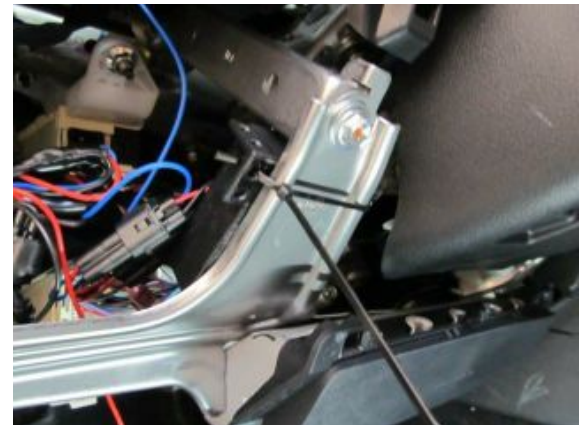

Picture 8

13. Install a black t-tap to connector K12 pin 19, blue wire. Then connect the red wire from DRL harness to the t-tap. Connector K12 is located in the driver side kick panel (pictures 9 and 10)

T-TAP RED WIRE OF DRL TO PIN 19 (blue wire)

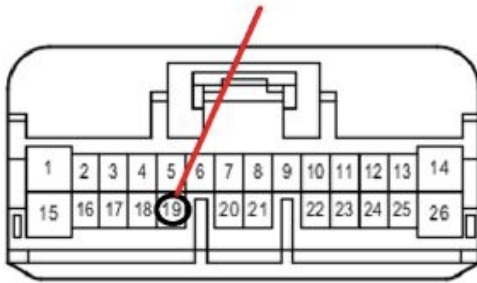

Picture 9: Connector K12



Picture 10

- 14. Install a black t-tap to connector I130 pin 5, green wire. Then connect the blue wire from DRL harness to the t-tap. Connector I130 is located at the back of the traction control switch (pictures 11 and 12)

T-TAP BLUE WIRE FROM DRL TO PIN 5 (green wire)

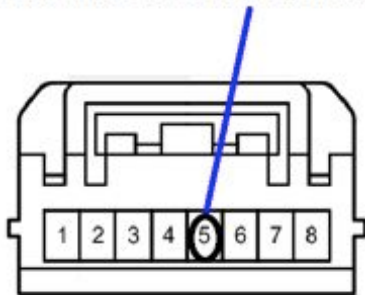

Picture 11



Picture 12

- 15. Secure ground (black) wire to bolt in kick panel (see picture 13)



Picture 13

- 16. Secure any excess wire and relay with wire ties
- 17. Reinstall airbag, dash panels and connectors. When reinstalling airbag in lower knee panel, follow specifications on picture 14

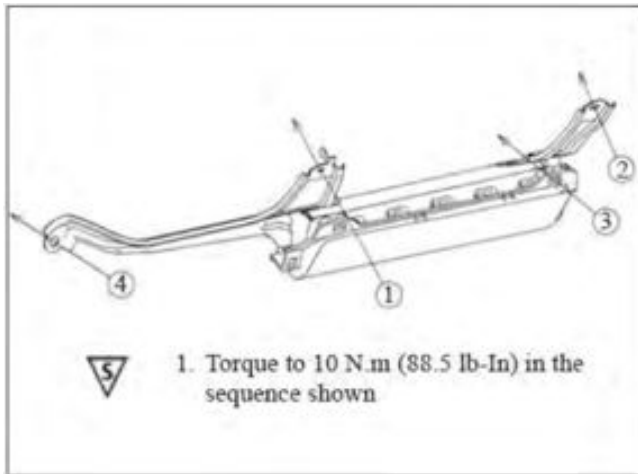

Picture 14

ENGINE COMPARTMENT

18. On the driver side, route the DRL's wire under car to reach left fog light area.
19. Remove lower splash shields on both sides and then fog light cover plates
20. Plug in left side DRL into harness plug and secure with wire ties. Snap on left DRL bezel in place
21. Run right side of wire harness under skid plate and secure with wire ties (picture 15)



Picture 15

22. Plug in right DRL into harness plug and secure with wire ties, then snap on DRL bezels (picture 16)



Picture 16

23. Reattach the lower splash shields
24. Hybrid models: Reconnect negative battery cable. Torque to 61 in-lb
1. Gas engine models: Reinstall battery, brackets & assembly if applicable. Torque battery terminals to 61 in-lb.

Check

Accessory Functions Checks

- DRL function.....
- All Panels snapped into place.....
- Battery Terminal.....

Vehicle Function checks

- Check functions all switch functions

Look For:

-
- Loose panels and switches
 - Re-torque battery terminals to 61 in/lbs.

VEHICLE FUNCTION CHECK

AFTER ALL PANELS, COVERS AND COMPONENTS THAT WERE REMOVED HAVE BEEN REINSTALLED, TEST THOROUGHLY ALL MECHANICAL AND ELECTRICAL COMPONENTS DISCONNECTED AND/OR REMOVED FROM THE VEHICLE DURING THE INSTALLATION OF THIS ACCESSORY