

Part Number: STC-314 / STC-814



Kit Contents

Item #	Quantity Reqd.	Description
1	2	Fog Lamps
2	2	Fog Light bezels
3	1	Switch Assembly
4	1	Fog Light Operation guide
5	1	Harness Bag

Hardware Bag Contents

Item #	Quantity Reqd.	Description
1	1	Switch harness
2	1	Wire harness
3	1	Relay
4	15	Wire ties
5	6	Phillip head screws
6	2	LED Connectors (for STC-814)

Conflicts

- Factory Installed Fog Lights

General Applicability





Models:

Recommended Tools

Safety Tools	
Safety Glasses	
Electrical Tape	
Installation Tools	
10mm Wrench	
Phillips Screw Driver	
Pliers	
Side Cutters	
Special Chemicals	
3M Silicon Sealant	

Mandatory

Legend

	STOP: Damage to the vehicle may occur. Do not proceed until process has been complied with.
	OPERATOR SAFETY: Use caution to avoid risk of injury
	CRITICAL PROCESS: Proceed with caution to ensure a quality installation.
	TOOLS & EQUIPMENT: This calls out the specific tools and equipment required for this process
	REVISION MARK: This mark highlights a change in installation with respect to previous issue

Care must be taken when installing this accessory to ensure damage does not occur to the vehicle. The installation of this accessory should follow approved guidelines to ensure quality installation.

Preparation



Remove negative battery cable

Vehicle Disassembly

1. Remove the engine cover (picture 1)

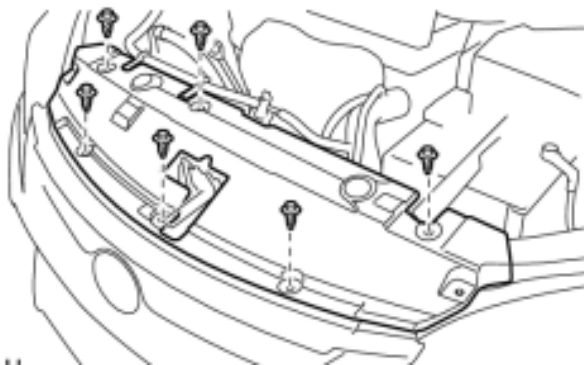

Picture 1

2. Remove screws from both fender liners (picture 2).



Picture 2

3. Pull fender liner aside for access to rear of lamp (picture 3)



Picture 3

4. Remove existing fog light cover on both sides (picture 4 and 4A). Remove the screw holding the bezel.

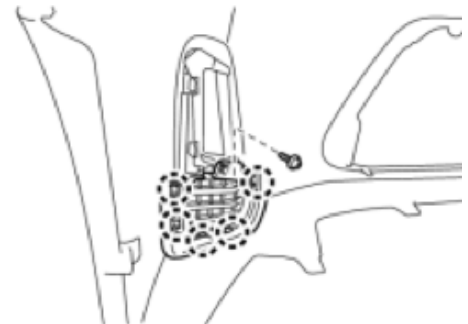

Picture 4



Picture 4A

Installation

5. Install the fog light bezels from behind bumper (picture 5).



Picture 5

6. For Halogen installations, proceed to step 7. For LED installations; The LED fog light wires may not be pushed into their connectors. If not, push the negative wire (black or black-white) into Pin 2 of the connector. Then, push the positive wire (red or red-white) into Pin 1 of the connector. See Picture 6 below.



LED Lights will NOT work if the polarity is reversed. Be sure the red positive wire of the harness matches the red positive wire of the light housing, and the black negative wire of the harness matches the black negative wire of the light housing.

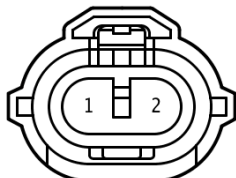

Picture 6

7. Mount the fog light housings into the bezels on each side of bumper (picture 7). Lamps are marked for installation on the left or right side of vehicle. Secure with Philip screws.



Picture 7

8. Locate the supplied wire harness. Route the short leg of the wire harness with the 2-pin connector down through the opening near the driver side of the battery. Plug it into the driver side fog lamp (picture 8).

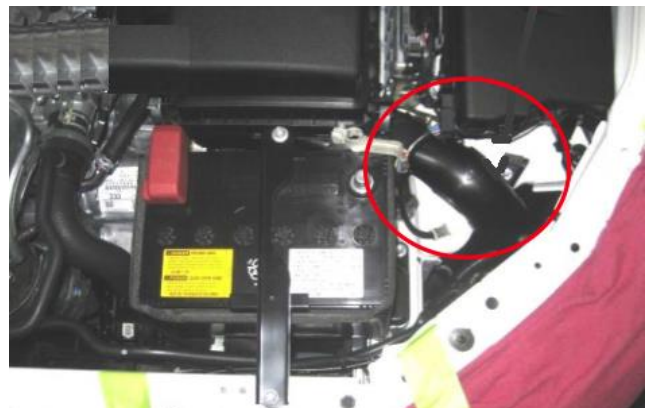

Picture 8

9. Route the long leg of the wire harness with its 2-pin connector underneath the battery retention and coolant overflow hose (picture 9).

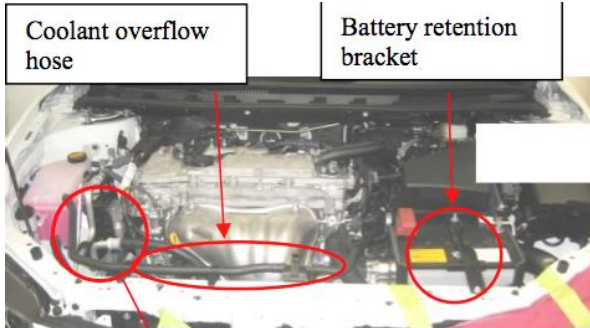

Picture 9

10. Continue routing the wire harness through the opening under passenger side headlight. Reach underneath the bumper to plug the harness connector into the passenger side fog lamp.

11. Route the wire harness with single-pin connector down beside battery (picture 11).

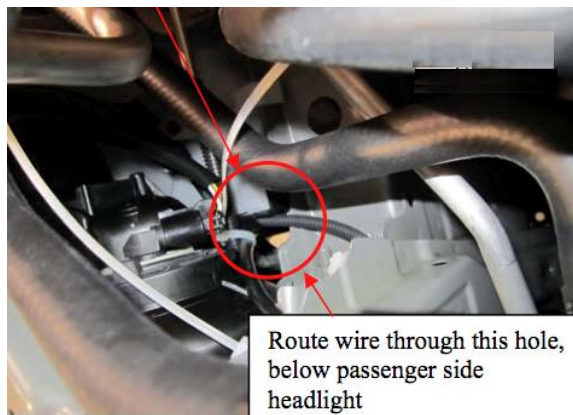

Picture 11

12. Locate the factory single-pin connector that is behind the driver side of the bumper (below and in front of battery). Connect the supplied harness to this factory single-pin connector (picture 12).

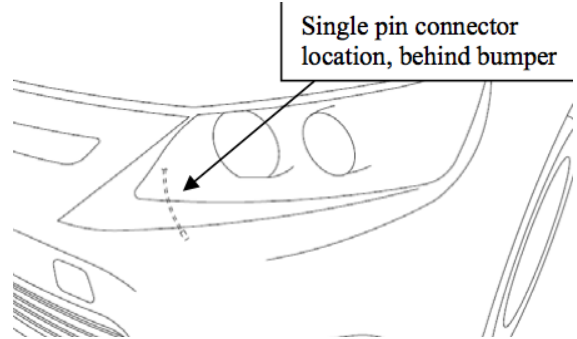

Picture 12

13. Attach the ground ring terminal of the fog lamps wire harness to the ground wire of the battery. Tighten to 48 in-lb (picture 13)

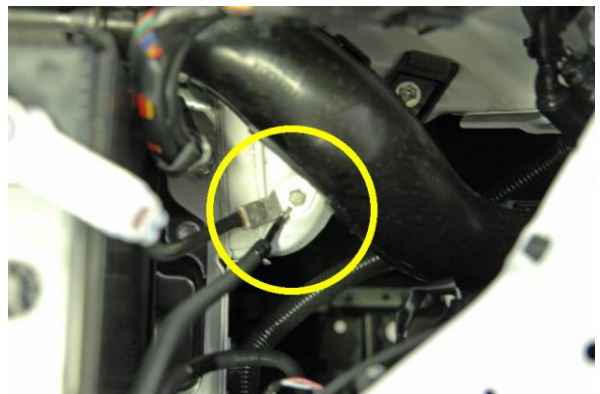

Picture 13

14. Secure the wire harness across the engine compartment with wire ties (pic. 14 & 14A)

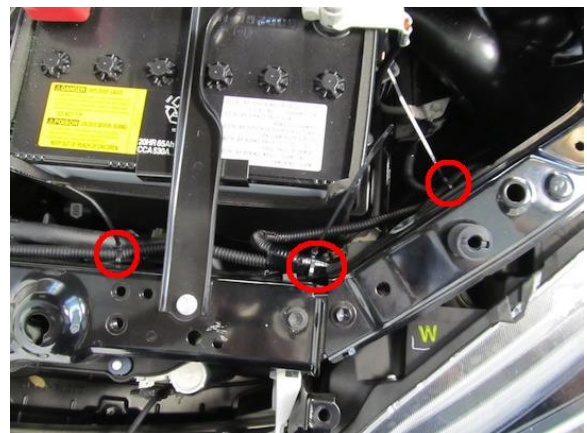

Picture 14

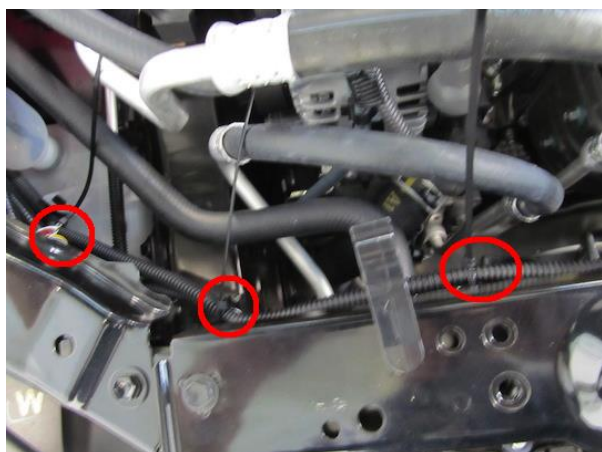

Picture 14A



Never attach anything to the airbag wire harness (picture 15)

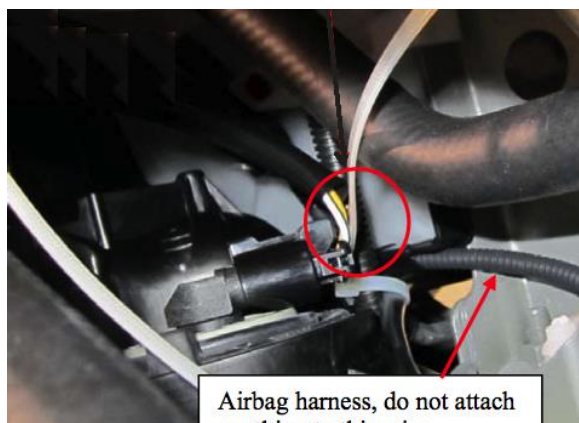

Airbag harness, do not attach anything to this wire

Picture 15

15. Reinstall fender liner

SWITCH INSTALLATION

16. Detach the mirror control panel and remove the right switch knock out from this panel (picture 18)

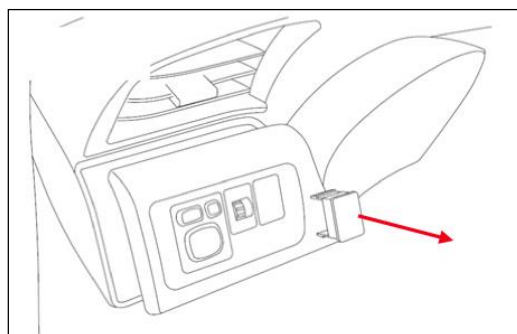

Picture 18

17. Find the 4-pin connector inside of instrument panel and remove electrical tape. Connect switch harness to factory 4-pin connector. Thread wire through opening in panel and connect it to fog lamp switch (picture 19)

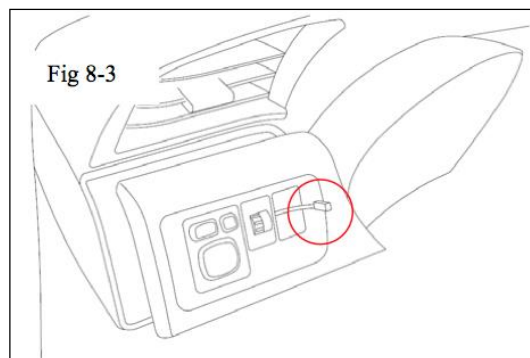

Picture 19

18. Mount switch into panel's knock out

19. Reinstall mirror control panels

20. Remove the radio head unit, by disengaging the five clips and two claws in the instrument cluster finish panel (picture 20)



Picture 20

21. Using a 10mm wrench, remove the 4 bolts that hold the radio head unit in place. Disconnect the wire harness from head unit (picture 21)

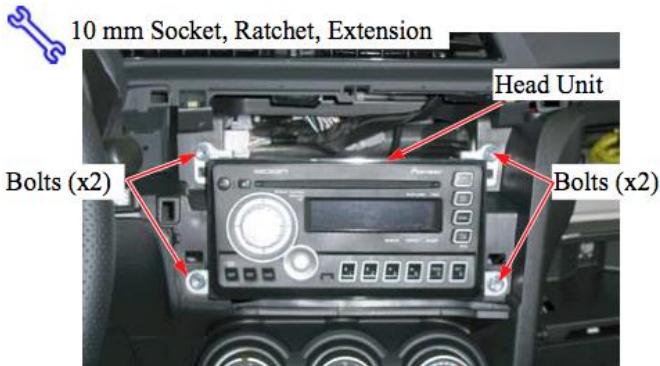

Picture 21

22. Loosen the screw holding the relay bracket in place, located behind the radio head unit (picture 22)

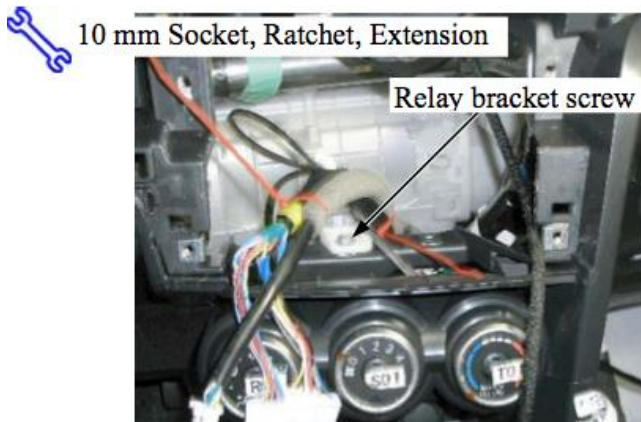

Picture 22

23. Raise bracket up and install the supplied relay in the middle port of the relay bracket (second port from down to top) (picture 23)

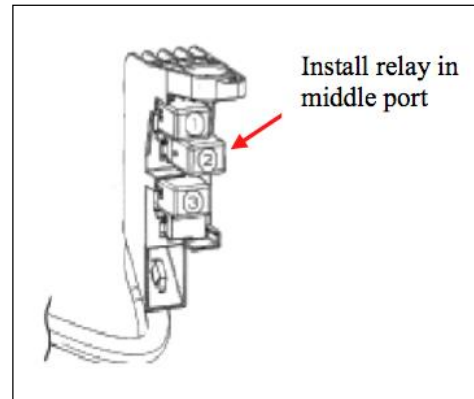

Picture 23

24. Reinstall radio head unit and instrument cluster finish

25. Reinstall cover over radiator

26. Reconnect negative battery cable. Torque to 36 in-lb.

Checklist – these points MUST be checked to ensure quality installation

Check System for Operation

1. Check that battery is connected
2. Turn on headlamp low beams, then press fog light switch to “ON” position. Fog lights should be working. Fog lights will only work when the low beam headlamps are “ON”. Fog lights will NOT work when the high beam headlamps are “ON”

Fog Light Aiming



NOTE: Use only hand tools to adjust the fog light aiming screw. DO NOT use power assisted tools, as they will damage the fog light.

Traditional fog lights are usually mounted in the front bumper about 10-24 inches from the ground. There are two important issues to address when installing fog lights: the first is to minimize the amount of return glare into the driver’s eyes, and the other is to minimize the glare into oncoming eyes. Both of these issues must be accomplished while putting as much light as possible on the road.

These fog weather light aiming instructions are suggestions taken from common practice and the S.A.E. standard J583. Some modifications to these instructions may be necessary to minimize glare.

Visual aim is made with the top of the beam 4 inches below the lamp center at 25 feet with the lamp facing straight forward (see picture 24)

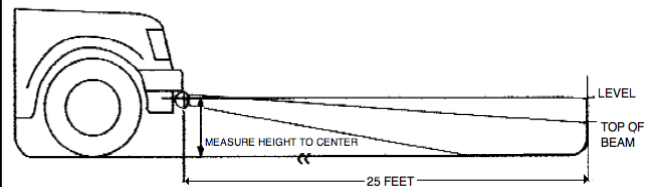

Picture 24

Check

Accessory Functions Checks

- Fog Lights function
- All Panels snapped into place.....
- Battery Terminal.....

Vehicle Function checks

- Check all vehicle functions

Look For:

- Inoperable fog light function
- Loose panels and switches
- Re-torque battery terminals to 36 in-lb

VEHICLE FUNCTION CHECK

AFTER ALL PANELS, COVERS AND COMPONENTS THAT WERE REMOVED HAVE BEEN REINSTALLED, TEST THOROUGHLY ALL MECHANICAL AND ELECTRICAL COMPONENTS DISCONNECTED AND/OR REMOVED FROM THE VEHICLE DURING THE INSTALLATION OF THIS ACCESSORY